



AFM60E-S1AA004096

AFS/AFM60 SSI

ABSOLUTE ENCODERS

SICK
Sensor Intelligence.



Illustration may differ



Ordering information

| Type | Part no. |
|-------------------|----------|
| AFM60E-S1AA004096 | 1037438 |

Other models and accessories → www.sick.com/AFS_AFM60_SSI

Detailed technical data

Performance

| | |
|---|---------------------------------|
| Max. resolution (number of steps per revolution x number of revolutions) | 12 bit x 12 bit (4,096 x 4,096) |
| Error limits G | 0.2° ¹⁾ |
| Repeatability standard deviation σ_r | 0.002° ²⁾ |

¹⁾ In accordance with DIN ISO 1319-1, position of the upper and lower error limit depends on the installation situation, specified value refers to a symmetrical position, i.e. deviation in upper and lower direction is the same.

²⁾ In accordance with DIN ISO 55350-13; 68.3% of the measured values are inside the specified area.

Interfaces

| | |
|---|--|
| Communication interface | SSI |
| Initialization time | 50 ms ¹⁾ |
| Position forming time | < 1 μ s |
| SSI | |
| Code type | Gray |
| Code sequence parameter adjustable | CW/CCW (V/R) parameter adjustable |
| Clock frequency | ≤ 1 MHz ²⁾ |
| Set (electronic adjustment) | H-active (L = 0 - 3 V, H = 4,0 - U _s V) |
| CW/CCW (counting sequence when turning) | L-active (L = 0 - 1,5 V, H = 2,0 - U _s V) |
| Sin/Cos | |
| Load resistance | $\geq 120 \Omega$ |

¹⁾ Valid positional data can be read once this time has elapsed.

²⁾ Minimum, LOW level (Clock +): 250 ns.

Electrical data

| | |
|------------------------|-------------------------------------|
| Connection type | Male connector, M23, 12-pin, radial |
|------------------------|-------------------------------------|

¹⁾ This product is a standard product and does not constitute a safety component as defined in the Machinery Directive. Calculation based on nominal load of components, average ambient temperature 40°C, frequency of use 8760 h/a. All electronic failures are considered hazardous. For more information, see document no. 8015532.

| | |
|--|--|
| Supply voltage | 4.5 ... 32 V DC |
| Power consumption | ≤ 0.7 W (without load) |
| Reverse polarity protection | ✓ |
| MTTFd: mean time to dangerous failure | 250 years (EN ISO 13849-1) ¹⁾ |

¹⁾ This product is a standard product and does not constitute a safety component as defined in the Machinery Directive. Calculation based on nominal load of components, average ambient temperature 40 °C, frequency of use 8760 h/a. All electronic failures are considered hazardous. For more information, see document no. 8015532.

Mechanical data

| | |
|---|---|
| Mechanical design | Solid shaft, Servo flange |
| Shaft diameter | 6 mm |
| Shaft length | 10 mm |
| Weight | 0.3 kg ¹⁾ |
| Shaft material | Stainless steel |
| Flange material | Aluminum |
| Housing material | Aluminum die cast |
| Start up torque | < 0.5 Ncm ²⁾ |
| Operating torque | < 0.3 Ncm ²⁾ |
| Permissible Load capacity of shaft | 80 N / radial 40 N / axial |
| Moment of inertia of the rotor | 6.2 gcm ² |
| Bearing lifetime | 3.0 x 10 ⁹ revolutions |
| Angular acceleration | + 500,000 rad/s ² |
| Operating speed | ≤ 9,000 min ⁻¹ ³⁾ |

¹⁾ Relates to devices with male connector connection.

²⁾ At 20 °C.

³⁾ Allow for self-heating of approx. 3.3 K / 1,000 rpm when designing the operating temperature range.

Ambient data

| | |
|--------------------------------------|--|
| EMC | According to EN 61000-6-2 and EN 61000-6-3 ¹⁾ |
| Enclosure rating | IP65, shaft side (according to IEC 60529) IP67, housing side (according to IEC 60529) ²⁾ |
| Permissible relative humidity | 90 % (condensation of the optical scanning not permitted) |
| Operating temperature range | 0 °C ... +85 °C |
| Storage temperature range | -40 °C ... +100 °C, without package |
| Resistance to shocks | 50 g, 6 ms (according to EN 60068-2-27) |
| Resistance to vibration | 20 g, 10 Hz ... 2,000 Hz (according to EN 60068-2-6) |

¹⁾ EMC according to the standards quoted is achieved if shielded cables are used.

²⁾ For devices with connector connection: With mating connector mounted.

Classifications

| | |
|---------------------|----------|
| ECl@ss 5.0 | 27270502 |
| ECl@ss 5.1.4 | 27270502 |
| ECl@ss 6.0 | 27270590 |
| ECl@ss 6.2 | 27270590 |

| | |
|-----------------------|----------|
| ECl@ss 7.0 | 27270502 |
| ECl@ss 8.0 | 27270502 |
| ECl@ss 8.1 | 27270502 |
| ECl@ss 9.0 | 27270502 |
| ECl@ss 10.0 | 27270502 |
| ECl@ss 11.0 | 27270502 |
| ETIM 5.0 | EC001486 |
| ETIM 6.0 | EC001486 |
| ETIM 7.0 | EC001486 |
| UNSPSC 16.0901 | 41112113 |

Dimensional drawing (Dimensions in mm (inch))

Servo flange, radial plug connection M12 and M23

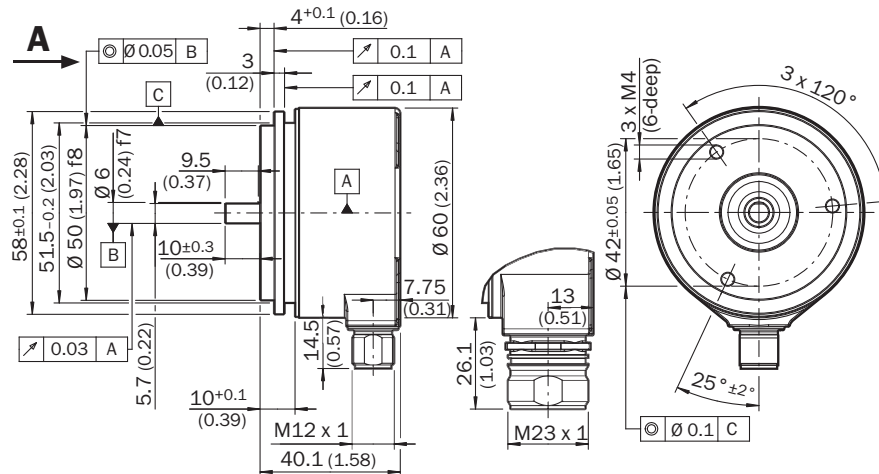

General tolerances according to DIN ISO 2768-mk

Attachment specifications

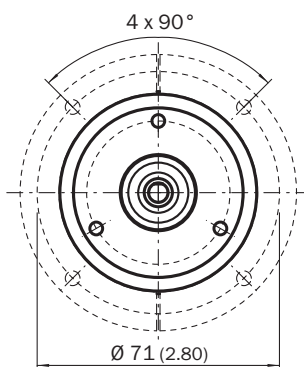

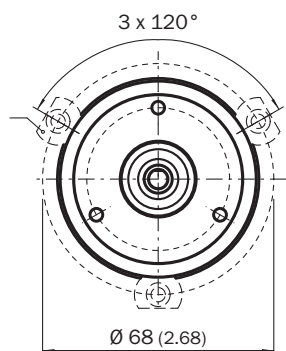

PIN assignment

M23 male connector, 12-pin, SSI/Gray

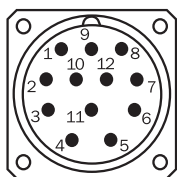

View of M23 male device connector on encoder

| PIN | Signal | Explanation |
|-----|----------------|---|
| 1 | GND | Ground connection |
| 2 | Data + | Interface signals |
| 3 | Clock + | Interface signals |
| 4 | N.C. | Not assigned |
| 5 | N.C. | Not assigned |
| 6 | N.C. | Not assigned |
| 7 | N.C. | Not assigned |
| 8 | U _S | Operating voltage |
| 9 | SET | Electronic adjustment |
| 10 | Data - | Interface signals |
| 11 | Clock - | Interface signals |
| 12 | V/R | Sequence in direction of rotation |
| | Screen | Screen connected to housing on encoder side. Connected to ground on control side. |

Maximum revolution range

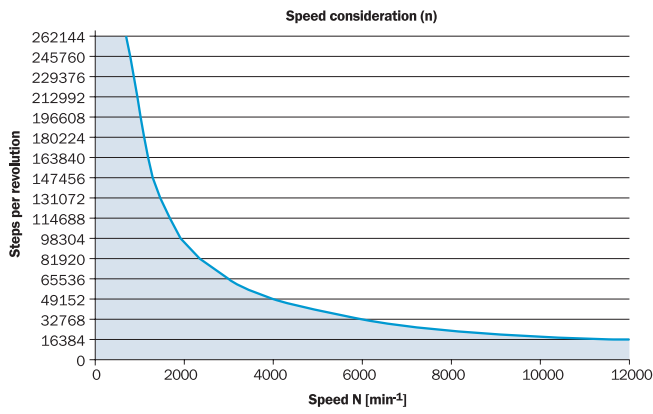

The maximum speed is also dependent on the shaft type.

Diagrams

SSI data format singleturn

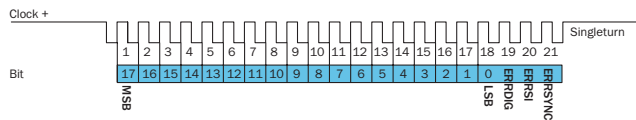

Bit 1–18: Position Bits

- LSB: Least significant Bit
- MSB: Most significant Bit

Bit 19–21: Error Bits

- ERRDIG: Failure message about speed. If this failure occurs during the position building procedure it will be indicated by the ERRDIG-Bit.
- ERRSI: Light source monitoring failure.
- ERRSYNC: Contamination of the disc or scanning system. During the determination of the position, an error has occurred since the last SSI transmission. The error bit will be deleted during the next data transmission.

The evaluation of the error bits has to be realized in the PLC.

The provided error bits don't have to be used by the PLC compulsorily.

Example

If the resolution of the absolute encoder is set on 13 bits, 16 bits are provided by the encoder: 13 data bits and 3 error bits. If the PLC is not able to evaluate the error bits, the PLC has to be set on a resolution of 13 bits. Then the error bits have to be masked out by the PLC.

SSI data format multiturn

30 Bits

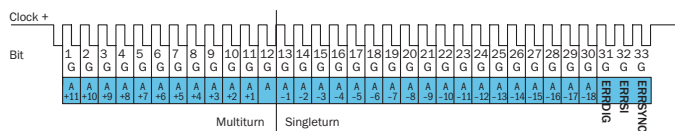

- Bit 1–12: Position Bits multiturn
- Bit 13–30: Position Bits singleturn
- Bit 31–33: Error Bits

27 Bits

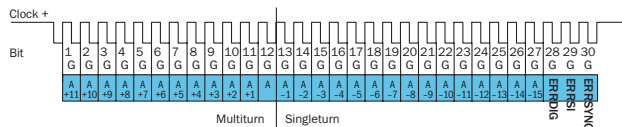

- Bit 1–12: Position Bits multiturn
- Bit 13–27: Position Bits singleturn
- Bit 28–30: Error Bits

Error Bits

- ERRDIG: Failure message about speed. If this failure occurs during the position building procedure it will be indicated by the ERRDIG-Bit.
- ERRSI: Light source monitoring failure.
- ERRSYNC: Contamination of the disc or scanning system. During the determination of the position, an error has occurred since the last SSI transmission. The error bit will be deleted during the next data transmission.

The evaluation of the error bits has to be realized in the PLC.

The provided error bits don't have to be used by the PLC compulsorily. The multiturn resolution is fixed on 12 bits.

Example

If the resolution of the absolute encoder is set on 27 bits, 30 bits are provided by the encoder: 27 data bits and 3 error bits. If the PLC is not able to evaluate the error bits, the PLC has to be set on a resolution of 27 bits. Then the error bits have to be masked out by the PLC.

Electrical interfaces sine $0.5 V_{pp}$

| Power supply | Output |
|---------------|-------------------|
| 4.5 ... 5.5 V | Sine $0.5 V_{pp}$ |

Signal **before** differential generation at load 120Ω at $U_s = 5 V$

Signal diagram for clockwise rotation of the shaft looking in direction "A" (shaft)

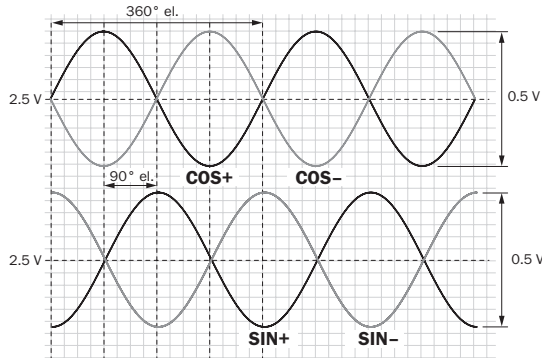

| Interface signals $\text{Sin}, \overline{\text{Sin}}, \text{Cos}, \overline{\text{Cos}}$ | Signal before differential generation at load 120Ω | Signal offset |
|--|--|-------------------|
| Analog differential | $0.5 V_{pp} \pm 20 \%$ | $2.5 V \pm 10 \%$ |

Signal **after** differential generation at load 120Ω at $U_s = 5 V$

Signal diagram for clockwise rotation of the shaft looking in direction "A" (shaft)

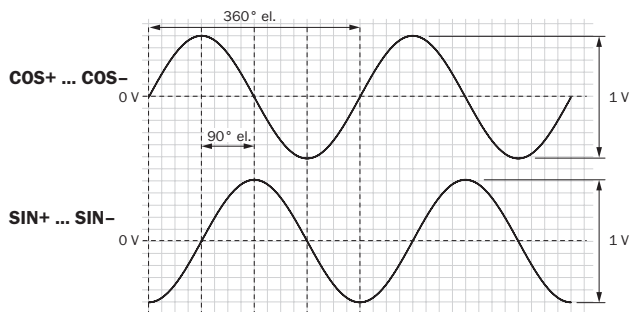











Electrical interfaces HTL/TTL

Incremental pulse diagram for clockwise rotation of the shaft looking in direction "A", see dimensional drawing



Recommended accessories

Other models and accessories → www.sick.com/AFS_AFM60_SSI

| | Brief description | Type | Part no. |
|---|---|------------------|----------|
| Other mounting accessories | | | |
|  | Servo clamps, large, for servo flanges (clamps, eccentric fastener), 3 pcs., without mounting material, without mounting hardware | BEF-WK-SF | 2029166 |
| Shaft adaptation | | | |
|  | Bellows coupling, shaft diameter 6 mm / 6 mm, maximum shaft offset: radial ± 0.25 mm, axial ± 0.4 mm, angular +/- 4°; max. speed 10,000 rpm, -30 °C to +120 °C, max. torque 80 Ncm; material: stainless steel bellows, aluminum hub | KUP-0606-B | 5312981 |
|  | Bar coupling, shaft diameter 6 mm / 6 mm, maximum shaft offset: radial ± 0.3 mm, axial ± 0.2 mm, angle ± 3°; max. speed 10,000 rpm, -10° to +80 °C, max. torque 80 Ncm; material: fiber-glass reinforced polyamide, aluminum hub | KUP-0606-S | 2056406 |
| | Bar coupling, shaft diameter 6 mm / 8 mm, maximum shaft offset radial ± 0.3 mm, axial ± 0.2 mm, angle ± 3°, max. speed 10,000 rpm, torsion spring rigidity 38 Nm/wheel; material: fiber-glass reinforced polyamide, aluminum hub | KUP-0608-S | 5314179 |
|  | Bellows coupling, shaft diameter 6 mm / 10 mm, maximum shaft offset: radial ± 0.25 mm, axial ± 0.4 mm, angular +/- 4°; max. speed 10,000 rpm, -30 °C to +120 °C, max. torque 80 Ncm; material: stainless steel bellows, aluminum hub | KUP-0610-B | 5312982 |
|  | Double loop coupling, shaft diameter 6 mm / 10 mm, max. shaft offset: radially +/- 2,5 mm, axially +/- 3 mm, angle +/- 10 degrees; max. speed 3.000 rpm, -30 to +80 degrees Celsius, torsional spring stiffness of 25 Nm/rad | KUP-0610-D | 5326697 |
|  | Spring washer coupling, shaft diameter 6 mm / 10 mm, Maximum shaft offset: radial +/- 0.3 mm, axial +/- 0.4 mm, angular +/- 2.5°; max. speed 12,000 rpm, -10° to +80 °C, max. torque 60 Ncm; material: aluminum flange, glass fiber-reinforced polyamide membrane and hardened steel coupling pin | KUP-0610-F | 5312985 |
|  | Bar coupling, shaft diameter 6 mm / 10 mm, max. shaft offset: radial ± 0,3 mm, axial ± 0,3 mm, angular ± 3°; max. speed 10.000 rpm, -10° to +80 °C, max. torque: 80 Ncm, material: fiber-glass reinforced polyamide, aluminum hub | KUP-0610-S | 2056407 |
| Plug connectors and cables | | | |
|  | Head A: cable Head B: Flying leads Cable: SSI, Incremental, HIPERFACE®, PUR, halogen-free, shielded | LTG-2308-MWENC | 6027529 |
|  | Head A: female connector, M23, 12-pin, straight Head B: Flying leads Cable: SSI, PUR, halogen-free, shielded, 3 m | DOL-2308-G03MAA6 | 2048597 |
| | Head A: female connector, M23, 12-pin, straight Head B: Flying leads Cable: SSI, PUR, halogen-free, shielded, 5 m | DOL-2308-G05MAA6 | 2048598 |
| | Head A: female connector, M23, 12-pin, straight Head B: Flying leads Cable: SSI, PUR, halogen-free, shielded, 0.5 m | DOL-2308-G0M5AA6 | 2048595 |
| | Head A: female connector, M23, 12-pin, straight Head B: Flying leads Cable: SSI, PUR, halogen-free, shielded, 10 m | DOL-2308-G10MAA6 | 2048599 |
| | Head A: female connector, M23, 12-pin, straight Head B: Flying leads Cable: SSI, PUR, halogen-free, shielded, 1.5 m | DOL-2308-G1M5AA6 | 2048596 |
|  | Head A: female connector, M23, 12-pin, straight Head B: - Cable: HIPERFACE®, SSI, Incremental, shielded | DOS-2312-G | 6027538 |
| | | DOS-2312-G02 | 2077057 |

| | Brief description | Type | Part no. |
|---|--|--------------|----------|
|  | Head A: female connector, M23, 12-pin, angled Head B: - Cable: HIPERFACE [®] , SSI, Incremental, shielded | DOS-2312-W01 | 2072580 |

SICK AT A GLANCE

SICK is one of the leading manufacturers of intelligent sensors and sensor solutions for industrial applications. A unique range of products and services creates the perfect basis for controlling processes securely and efficiently, protecting individuals from accidents and preventing damage to the environment.

We have extensive experience in a wide range of industries and understand their processes and requirements. With intelligent sensors, we can deliver exactly what our customers need. In application centers in Europe, Asia and North America, system solutions are tested and optimized in accordance with customer specifications. All this makes us a reliable supplier and development partner.

Comprehensive services complete our offering: SICK LifeTime Services provide support throughout the machine life cycle and ensure safety and productivity.

For us, that is “Sensor Intelligence.”

WORLDWIDE PRESENCE:

Contacts and other locations –www.sick.com